

KOMATSU®

PC210LC-11 PC210LCi-11

Tier 4 Final Engine

intelligent / 2.0
MACHINE CONTROL

HYDRAULIC EXCAVATOR



Photo may include optional equipment.

NET HORSEPOWER

165 HP @ 2,000 rpm
123 kW @ 2,000 rpm

OPERATING WEIGHT

51,397-53,882 lbs.
23,313-24,440 kg

BUCKET CAPACITY

0.66-1.57 yd³
0.50-1.20 m³

PC210LC / PC210LCi

WALK-AROUND



NET HORSEPOWER

165 HP @ 2,000 rpm
123 kW @ 2,000 rpm

OPERATING WEIGHT

51,397-53,882 lbs.
23,313-24,440 kg

BUCKET CAPACITY

0.66-1.57 yd³
0.50-1.20 m³

Photos may include optional equipment.

PG210LG-11 / PG210LGH-11



MAKE EVERY PASS COUNT

Improve your efficiency – intelligent Machine Control means fast excavation to finish grade.

Semi-automatic operation – new features such as bucket angle hold control provide high levels of accuracy and comfort.

Innovative

- intelligent Machine Control excavator features semi-automatic operation of work equipment for highly accurate work.
- NEW**
- Compact 10.4" IMC monitor with increased memory capacity, processing speed, and pinch to zoom capability.

Integrated

- Complete factory-installed and integrated intelligent Machine Control system comes standard with stroke sensing hydraulic cylinders, multiple Global Navigation Satellite System (multi-GNSS) components and an Inertial Measurement Unit (IMU) sensor. All components are validated to Komatsu's rigid quality and durability standards.

NEW

- Multi-band UHF/915SS radio improves job site flexibility.

NEW

- 4G LTE connectivity for fast reliable job site connectivity.

Intelligent

- intelligent Machine Control excavator allows the operator to focus on moving material efficiently while semi-automatically tracing the target surface and limiting over-excavation.
 - Facing angle compass, light bar and sound guidance aid in ease of operation and bucket positioning.
- NEW**
- Bucket Angle Hold and optional Auto-Tilt Control increase ease of operation and improve productivity and efficiency.



INTELLIGENT MACHINE CONTROL

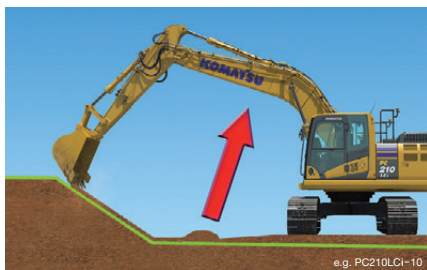

Photo may include optional equipment.

Intelligent Machine Control

Intelligent Machine Control is based on Komatsu's unique sensor package, including stroke sensing hydraulic cylinders, an IMU sensor, and GNSS antennas. It utilizes 3D design data loaded in the control box to accurately check its position against the target. If the bucket hits the target surface,

it is semi-automatically limited to minimize over-excavation. If the operator turns off Auto mode, the machine can be operated with highly accurate, responsive machine guidance, with the machine only providing indication guidance.



• Auto grade assist

With the auto grade assist function, the operator moves the arm, the boom adjusts the bucket height automatically, tracing the target surface and minimizing digging too deep. This allows the operator to perform rough digging without worrying about the design surface, and to perform fine digging by operating the arm lever only. The working range is extended by holding the lever to move the boom downward.

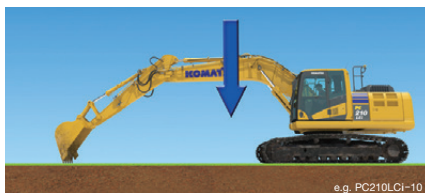

• Auto stop control

During boom or bucket operation, the work equipment automatically stops when the bucket edge reaches the design surface, thus minimizing damage to the design surface.



• Minimum distance control

The intelligent Machine Control excavator controls the bucket by automatically selecting the point on the bucket closest to the target surface. Should the machine not be facing a sloped surface at a right angle, it will still follow the target surface and minimize digging below it.

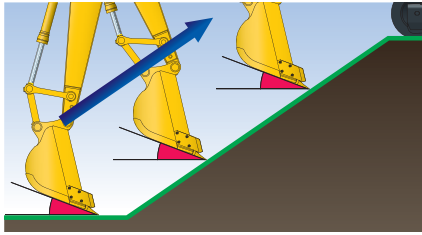

• Bucket angle hold control

Operator sets desired bucket angle and the system automatically maintains bucket angle throughout the grading pass. Angle hold control increases ease of operation and improves final grading accuracy.

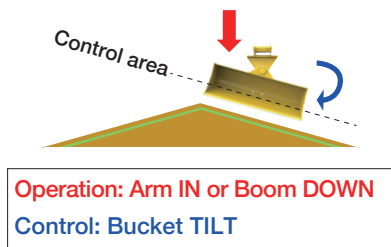

• Auto tilt control

Automatically tilts bucket to design surface and returns it to horizontal to unload. Using auto tilt control with the existing minimum distance control and auto grade assist makes complex grading quicker and easier.

Improved Construction Efficiency

Staking, survey and final inspection (which is usually done manually), can be reduced with the intelligent Machine Control excavator by setting 3D design data on the control box. Also, use of the facing angle compass can minimize leveling work for the surface on which the machine sits. Even if the machine is inclined while working, the facing angle compass allows the operator to ensure that the machine is facing perpendicular to the target surface. The intelligent Machine Control technology allows the operator to improve work efficiency (i.e. shorter construction time) while minimizing over-excavating the target surface from rough digging to finish grading.

Comparison of Construction Time Based On In-House Test of Excavation and Grading Slope Surface*

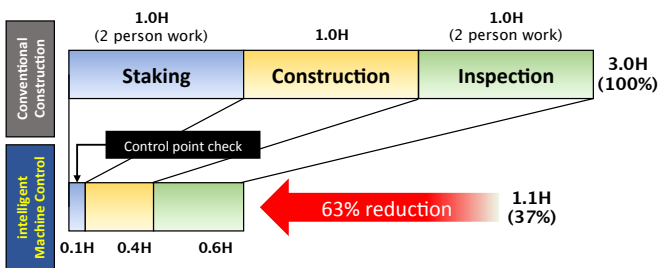

* When used by a qualified iMC operator, the Komatsu intelligent Machine Control system increases construction efficiency.
 * The above data does not include design time or working data creation time.
 The above data is based on in-house construction tests, performed by Komatsu, whose conditions may differ from actual construction.

Improved Work Accuracy

The bucket edge/tip position is instantly displayed on the control box, eliminating the wait time for display on the monitor during construction. The large and easy-to-view control box displays information clearly, aiding in highly accurate work. With manual operation and conventional machine guidance, finish grade quality and excavating accurately depends heavily on the skill of the operator. With the intelligent Machine Control excavator, the bucket is automatically limited to follow the target grade without over-excavating.

Relationship Between Finished Surface and Allowable Value

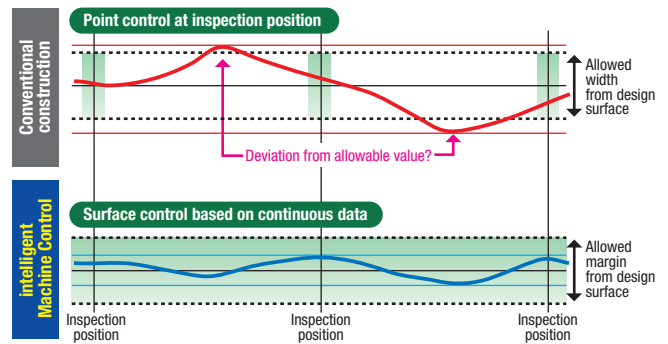

As-Built Surface Mapping

Operator can display and check the as-built status and find where to cut and fill.

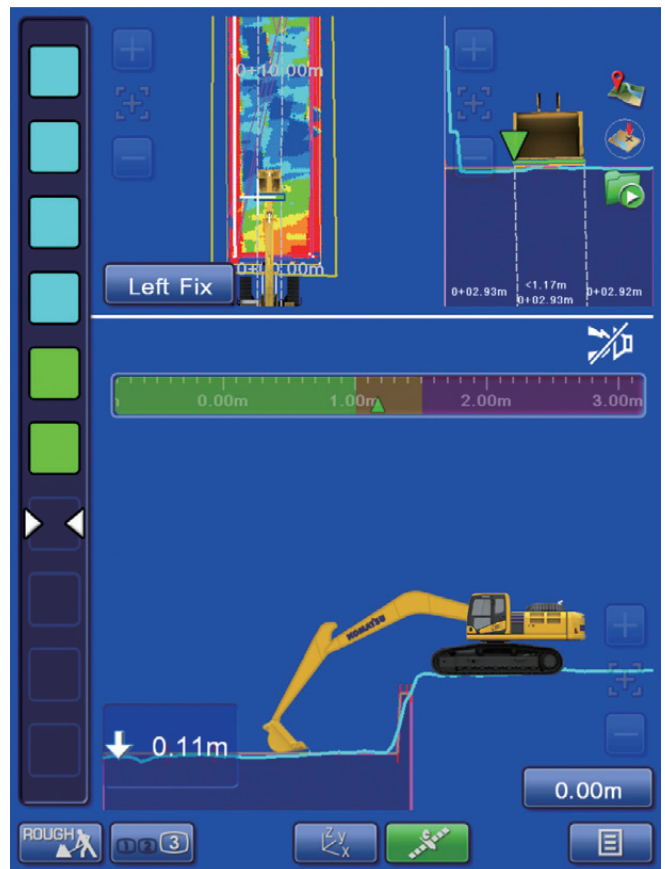

iNTELLIGENT MACHINE CONTROL

CONTROL BOX

The monitor of the Komatsu intelligent Machine Control (control box) uses a compact 10.4" screen for visibility and ease of use. The simple screen layout displays the necessary information in an easily understood fashion. Touch screen icon interface instead of multi-step menu simplifies operation.

Facing angle compass
Light bar

Auto/Manual switch

Bucket edge position selection button
Used to select the bucket edge position (left/middle/right/minimum distance) to determine the distance from the design surface

Pop-up map button
Displays a wide-area map

Edge position recording button

Sound guidance ON/OFF

Distance from design surface

Bucket edge position check button

GNSS signal reception status check button
Used to check signal reception from the GNSS

Mode selection button
Driving, Rough digging, Fine digging modes

Design surface offset
The design surface can be offset in the vertical direction

Screen selection button
Use to change the screen layout

Main menu button
For various settings

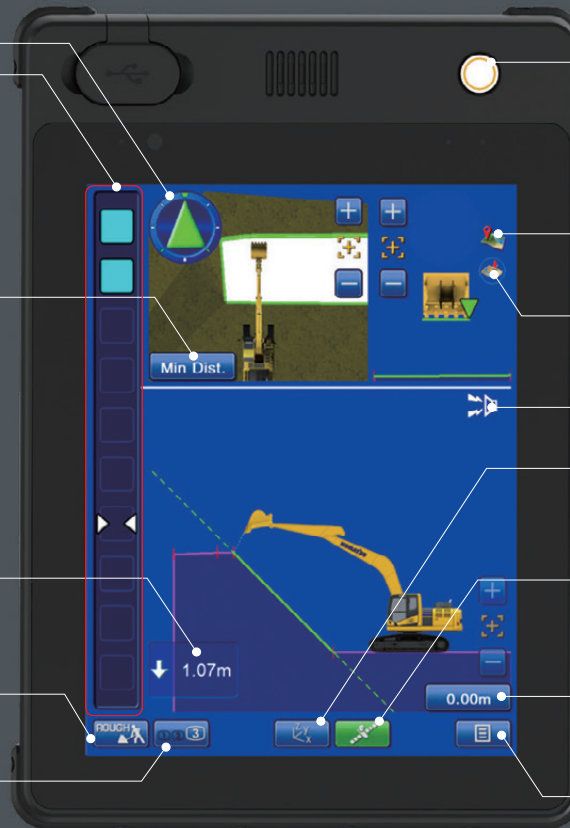

Preset Elevation Offset Quick Button

Pre-determined offsets can be stored in the monitor to allow an operator to easily switch between preset grades.

Offset preset	0.000'	Apply
	0.500'	Apply
	1.500'	Apply
Button switch mode	Offset preset	

Quick Bucket Swap Button

Allows users to quickly swap between various buckets without having to enter main menu. This lessens the time a user takes to change out a bucket on the monitor.



Machine Navigation

Facing angle compass

The orientation and color of the facing angle compass's arrow shows the operator the facing angle of the bucket edge relative to the target surface. This allows the bucket edge to be accurately positioned square with the target surface, which is useful when finishing slopes.



Enhanced operability of the machine control

Semi-auto/manual mode switching and design surface offset function can be operated with switches on the control levers.



Factory installed Komatsu intelligent Machine Control components.

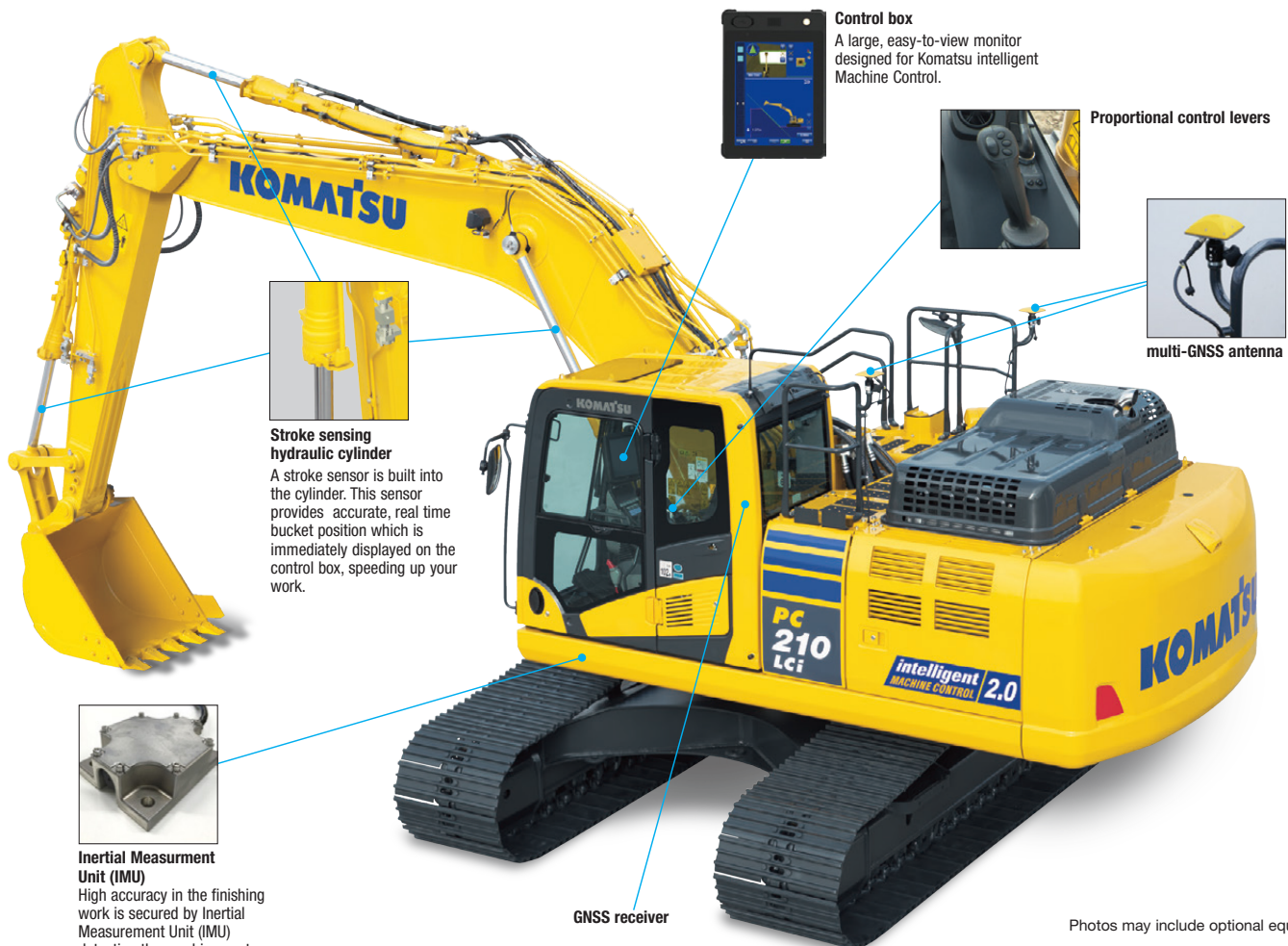

Control box
A large, easy-to-view monitor designed for Komatsu intelligent Machine Control.



Proportional control levers



multi-GNSS antenna

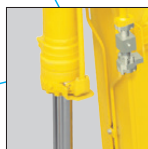

Stroke sensing hydraulic cylinder
A stroke sensor is built into the cylinder. This sensor provides accurate, real time bucket position which is immediately displayed on the control box, speeding up your work.

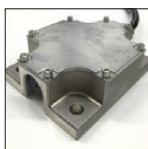

Inertial Measurement Unit (IMU)
High accuracy in the finishing work is secured by Inertial Measurement Unit (IMU) detecting the machine posture.

GNSS receiver

Photos may include optional equipment.

SMARTCONSTRUCTION Remote

Remote allows customers to quickly send design files to their intelligent machines and provide support to operators in the machine.



Users can log-in to Remote, locate machines by job site to upload or download design files at any time.

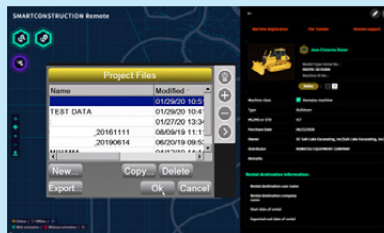

View the machine monitor to troubleshoot or add new files in the machine without the time requirements of traditional methods.



Capable of connecting to mixed fleet customers.



View or navigate machine monitor live with operator.

iNTELLIGENT MACHINE CONTROL

Work smarter from rough digging to finish grade

Give your operators the power to work more effectively than with conventional aftermarket machine guidance (indicate only) or manual operation. Intelligent Machine Control (iMC) excavators with semi-automatic control offer the capability to work smart from rough digging to finish grading, and help minimize over-excavation to make every pass count.

- Semi-automatic for trenching, slope work and high production applications
- Protection + precision + performance = the formula for pursuing maximum productivity versus conventional machine guidance



PG210LG-11 / PG210LGH-11

Working smarter in every way

Benefits of iMC 2.0



Save money

Frees GPS Dozer from need to achieve final grade so it can work elsewhere on the site.



Save time

Reduce staking, grading and inspection with 3D design data and semi-automatic grading.



Less time grade checking

Monitor performance and stay on grade from the cab: operators spend time working, not grade checking.



Improve accuracy

Continuously monitor grade and semi-automatics to dig precisely to grade.

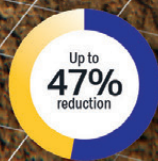

Reduce base aggregate

Greatly reduce over-digging and the amount of costly base aggregate needed for applications like utilities.

**All savings, improvements, and reductions are compared to traditional grading methods.*



PERFORMANCE FEATURES

Increased Work Efficiency

Powerful digging force

With the one-touch Power Max. function digging force is increased. (8.5 seconds of operation)

Maximum arm crowd force (ISO)

101 kN(10.3t) ➔ 108 kN(11.0t) 7% UP
(with Power Max.)

Maximum bucket digging force (ISO)

138 kN(14.1t) ➔ 149 kN(15.2t) 8% UP
(with Power Max.)

Measured with Power Max. function, 3045 mm arm and ISO rating



Large Displacement High Efficiency Pump

Large displacement hydraulic implement pumps provide high flow output at lower engine RPM as well as operation at the most efficient engine speed.

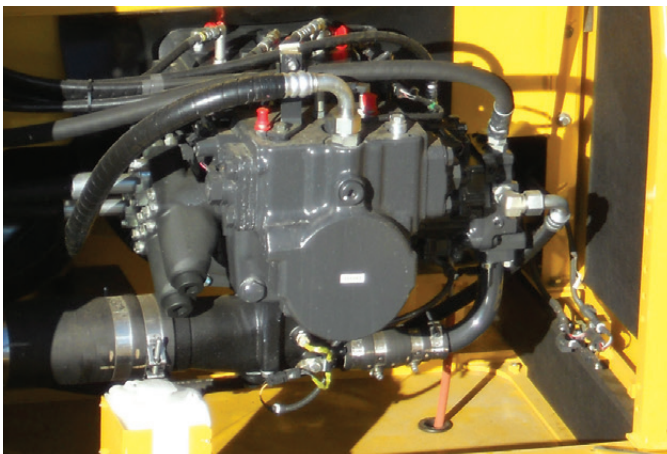

Working Mode Selection

The PC210LCi-11 excavator is equipped with six working modes (P, E, L, B, ATT/P and ATT/E). Each mode is designed to match engine speed, pump flow, and system pressure to the application. The PC210LCi-11 features an attachment mode (ATT/E) that allows operators to run attachments while in Economy mode.

Working Mode	Application	Advantage
P	Power mode	<ul style="list-style-type: none"> •Maximum production/power •Fast cycle times
E	Economy mode	<ul style="list-style-type: none"> •Good cycle times •Better fuel economy
L	Lifting mode	<ul style="list-style-type: none"> •Increases hydraulic pressure
B	Breaker mode	<ul style="list-style-type: none"> •Optimum engine rpm, hydraulic flow
ATT/P	Attachment Power mode	<ul style="list-style-type: none"> •Optimum engine rpm, hydraulic flow, 2-way •Power mode
ATT/E	Attachment Economy mode	<ul style="list-style-type: none"> •Optimum engine rpm, hydraulic flow, 2-way •Economy mode

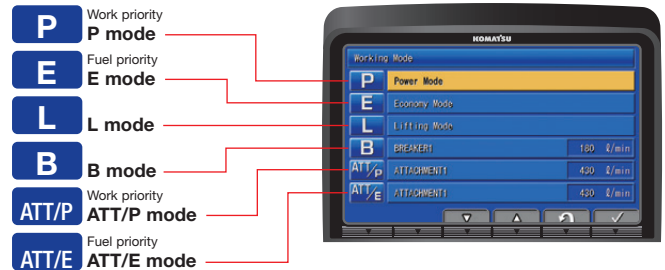

High Rigidity Work Equipment

Booms and arms are constructed with thick plates of high tensile strength steel. In addition, these structures are designed with large cross sectional areas and large one piece castings in the boom foot, the boom tip, and the arm tip. The result is work equipment that exhibits long term durability and high resistance to bending and torsional stress. A standard HD boom design provides increased strength and reliability.

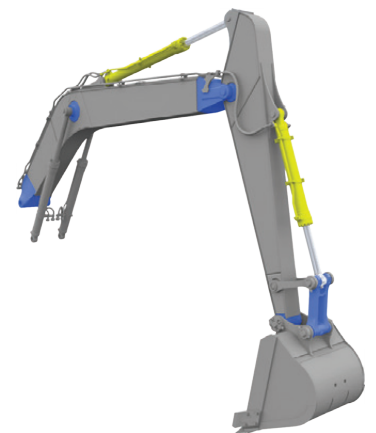

PC210LCi-11 / PG210LCi-11



Komatsu Integrated Attachment Control (Optional)

Factory-integrated auxiliary hydraulic attachment control with programmable pressure and flow settings for up to 15 different tools. Settings can be easily changed from the machine monitor optimizing attachment control and performance. Proportional joysticks help expand versatility by giving the operator precise hydraulic attachment control.

*Not available on PC210LC-11



+1 Attachment Piping(Optional)

Factory-engineered auxiliary attachment circuit piping is designed and sized to work efficiently with the excavator main hydraulic system. Constructed of large diameter steel tubing with 4 bolt flange connections and robust mounting points, the auxiliary hydraulic piping is designed for durable, reliable use.

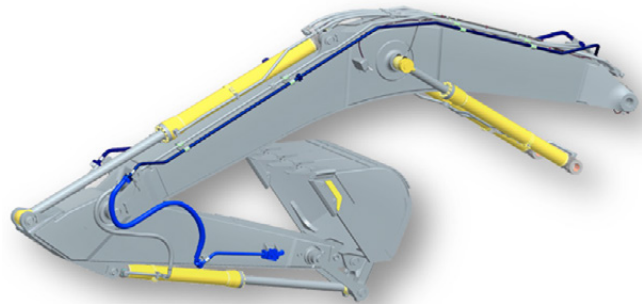

KOMATSU NEW ENGINE TECHNOLOGIES

New Tier 4 Final Engine

The Komatsu SAA6D107E-3 engine is EPA Tier 4 Final emissions-certified and provides exceptional performance while reducing fuel consumption. Based on Komatsu proprietary technologies developed over many years, this new diesel engine reduces nitrogen oxides (NOx) by more than 80% when compared to prior Komatsu Tier 4 levels. Through the in-house development and production of engines, electronics, and hydraulic components, Komatsu has achieved great advancements in technology, providing high levels of performance and efficiency in virtually all applications.

Technologies Applied to New Engine

Heavy-duty aftertreatment system

This new system combines a Diesel Particulate Filter (DPF) and Selective Catalytic Reduction (SCR). The SCR NOx reduction system injects the correct amount of Diesel Exhaust Fluid (DEF) at the proper rate, thereby decomposing NOx into non-toxic water vapor (H₂O) and nitrogen gas (N₂).

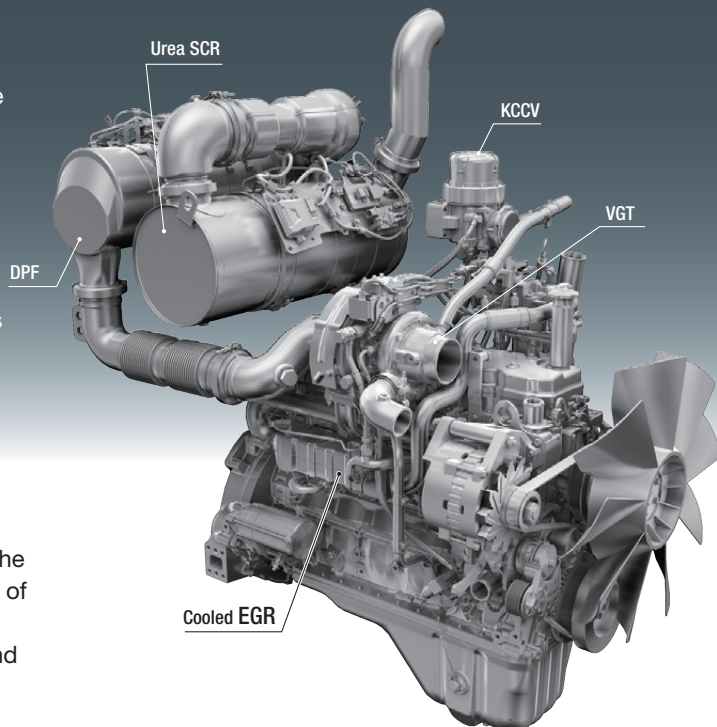

WORKING ENVIRONMENT



Photo may include optional equipment.

Comfortable Working Space

Wide spacious cab

The wide spacious cab includes a heated air suspension seat with reclining backrest. The seat height and position are easily adjusted using a pull-up lever. The armrest position is easily adjusted together with the console.

Arm rest with simple height adjustment function

A knob and plunger on the armrests allows easy height adjustment without the use of tools.



Low vibration with cab damper mounting

Automatic climate control

Pressurized cab

Auxiliary input jack

Connecting a regular audio device to the auxiliary jack allows the operator to hear the sound from the stereo speakers installed in the cab.



Standard Equipment

Sliding window glass (left side)



Radio



Remote intermittent wiper with windshield washer



Magazine box & cup holder



Opening & closing skylight



One-touch storable front window lower glass



Defroster (conform to the ISO standard)



LARGE HIGH RESOLUTION LCD MONITOR



New Monitor Panel Interface Design

An updated large high resolution LCD color monitor enables accurate and smooth work. The interface has been redesigned to display key machine information in a new user friendly interface. A rear view camera and an DEF level gauge display have been added to the default main screen. The interface has a function that enables the main screen mode to be switched, thus enabling the optimum screen information for the particular work situation to be displayed.

Indicators

- | | |
|------------------------------------|-----------------------------|
| 1 Auto-decelerator | 8 Fuel gauge |
| 2 Working mode | 9 DEF level gauge |
| 3 Travel speed | 10 Service meter, clock |
| 4 Ecology gauge | 11 Fuel consumption gauge |
| 5 Camera display | 12 Guidance icon |
| 6 Engine coolant temperature gauge | 13 Function switches |
| 7 Hydraulic oil temperature gauge | 14 Camera direction display |
| | 15 DEF level caution lamp |

Basic operation switches

- | | |
|-------------------------|-------------------------|
| 1 Auto-decelerator | 4 Buzzer cancel |
| 2 Working mode selector | 5 Wiper |
| 3 Travel speed selector | 6 Window washer |
| | 7 Auto climate controls |

KomVision (Optional)

Images from 4 camera's are combined to display a "birds eye" view of the area around the machine for improved operator awareness. A second display with selectable individual camera views of the left, rear, and right sides is easily changed using the F4 button. A red line continuously shows where the counterweight will be during swinging and a camera icon indicates which camera is being displayed on individual camera display screen.



Visual user menu

Pressing the F6 key on the main screen displays the user menu screen. The menus are grouped for each function, and use easy-to-understand icons which enable the machine to be operated easily.



- | | |
|---------------------------------------|--------------------|
| 1 Energy saving guidance | 2 Machine settings |
| 3 Aftertreatment devices regeneration | 4 SCR information |
| 5 Maintenance | 6 Monitor setting |
| | 7 Message check |

WORKING ENVIRONMENT

Support Efficiency Improvement

Ecology guidance

While the machine is operating, ecology guidance pops up on the monitor screen to notify the operator of the status of the machine in real time.

Ecology gauge & fuel consumption gauge

The monitor screen is provided with an ecology gauge and also a fuel consumption gauge which is displayed continuously. In addition, the operator can set any desired target value of fuel consumption (within the range of the green display), enabling the machine to be operated with better fuel economy.



Ecology gauge Fuel consumption gauge
Ecology guidance

Operation record, fuel consumption history, and ecology guidance record

The ecology guidance menu enables the operator to check the operation record, fuel consumption history and ecology guidance record from the ecology guidance menu, with a single touch.



Operation record

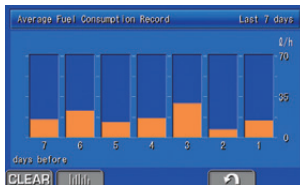

Fuel consumption history

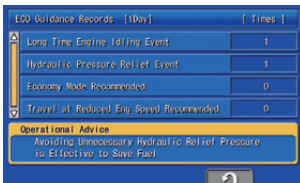

Ecology guidance record

Operator Identification Function

An operator identification ID can be set up for each operator, and used to manage operation information of individual machines using KOMTRAX data. Data sent from KOMTRAX can be used to analyze operation status by operator as well as by machine.



PG210LGI-11 / PG210LGI-11

MAINTENANCE FEATURES



Centralized engine check points

Locations of the engine oil check and filters are integrated into one side to allow easy maintenance and service.

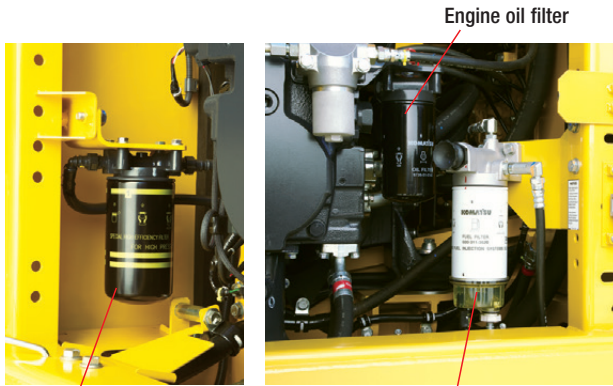

Engine oil filter

High efficiency fuel filter

Fuel pre-filter (with water separator)

Battery disconnect switch

A standard battery disconnect switch allows a technician to disconnect the power supply and lock out before servicing the machine.

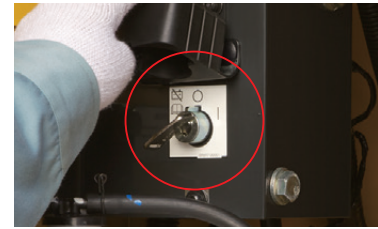

Easy to access air conditioner filter

Washable cab floor mat

Sloping track frame

Utility space

Easy cleaning of coolers

Side by side single panel engine and hydraulic oil coolers simplify maintenance.

Fuel pre-filter with water separator

Electric fuel priming pump

High efficiency fuel filter with water separator

Easy access to engine oil filter, engine oil, drain valve, fuel drain valve and water separator drain valve

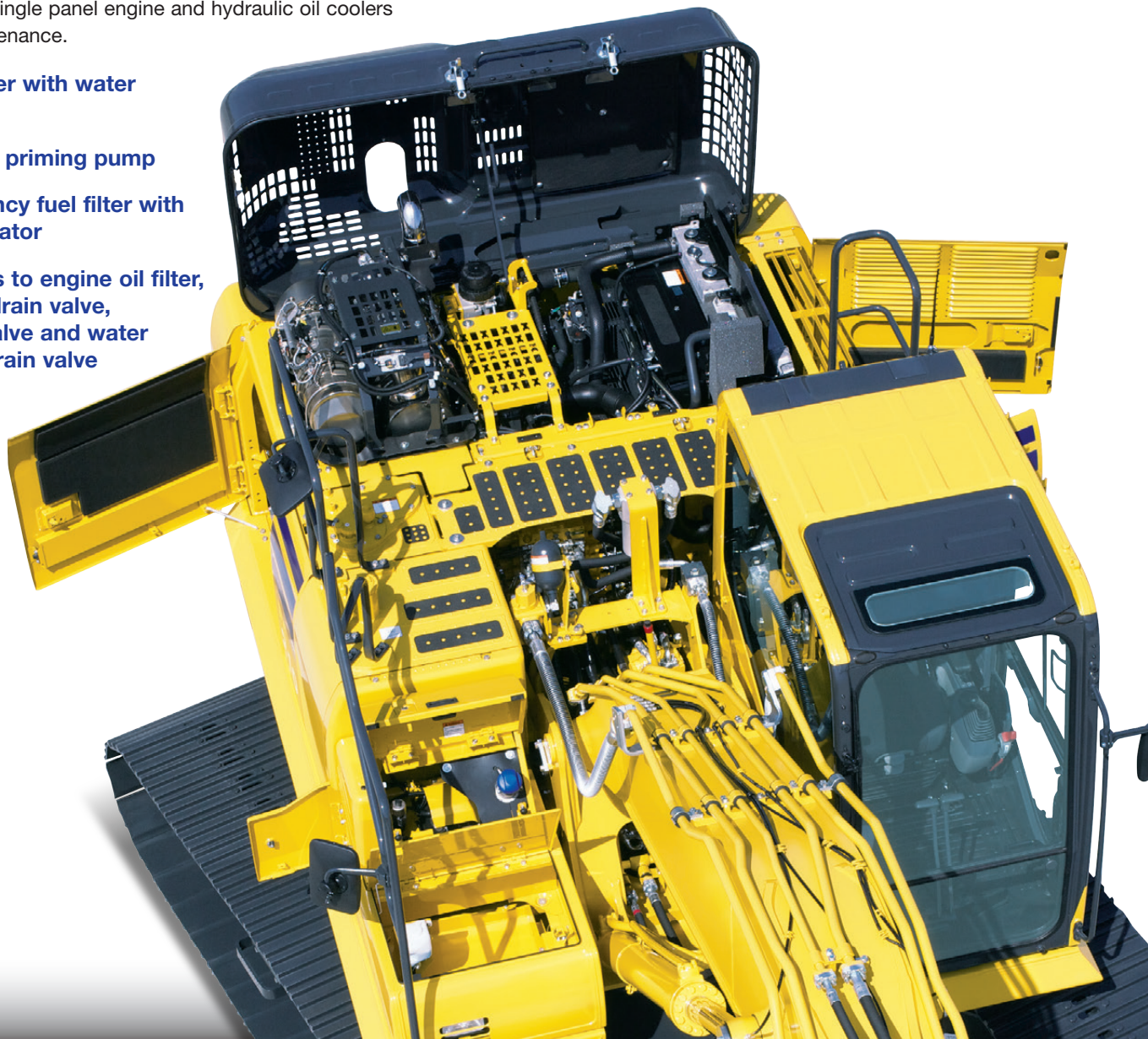

MAINTENANCE FEATURES

Long-life oils, filters

High performance filters are used in the hydraulic circuit and engine. By increasing the oil and filter replacement intervals, maintenance costs can be significantly reduced.



Hydraulic oil filter
(Ecology-white element)

Engine oil & Engine oil filter	every 500 hours
Hydraulic oil	every 5000 hours
Hydraulic oil filter	every 1000 hours
DEF pump filter	every 2000 hours

Large capacity air cleaner

Large capacity air cleaner is comparable to that of larger machines. The larger air cleaner can extend air cleaner life during long-term operation and helps prevent early clogging, and resulting power loss. A radial seal design is used for reliability.

Diesel Exhaust Fluid (DEF) tank

A large tank volume extends operating time before refilling and is installed on the right front stairway for ease of access.

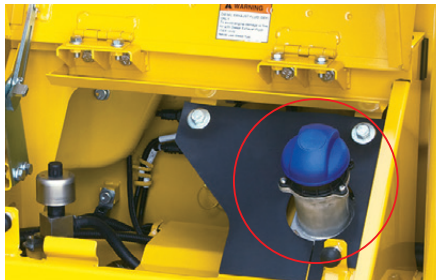

Maintenance Information

"Maintenance time caution lamp" display

When the remaining time to maintenance becomes less than 30 hours*, a maintenance time monitor appears. Pressing the F6 key switches the monitor to the maintenance screen.

* : The setting can be changed within the range between 10 and 200 hours.



Maintenance screen

Manual Stationary Regeneration

Under most conditions, active regeneration will occur automatically with no effect on machine operation. In case the operator needs to disable active regeneration or initiate a manual stationary regeneration, this can be easily accomplished through the monitor panel. A soot level indicator is displayed to show how much soot is trapped in the DPF.



Soot level indicator

Aftertreatment device regeneration screen

Supports the DEF level and refill timing

The DEF level gauge is displayed continuously on the right side of the monitor screen. In addition, when DEF level is low, DEF low level guidance messages appear in pop up displays to inform the operator in real time.



DEF level gauge

DEF low level guidance

DT-type connectors

Sealed DT-type electrical connectors provide high reliability, water and dust resistance.

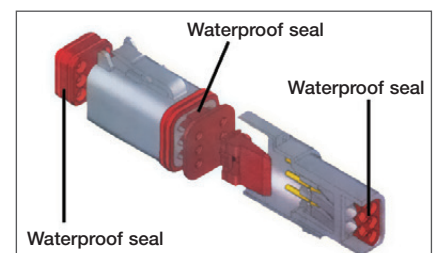

PG210LC-11 / PG210LGH-11

GENERAL FEATURES



ROPS CAB STRUCTURE

ROPS Cab (ISO 12117-2)

The machine is equipped with a ROPS cab that conforms to ISO 12117-2 for excavators as standard equipment. It also satisfies the requirements for Level 1 Operator Protective Guard (OPG) and top guard (ISO 10262).



Rear View Monitoring System

A new rear view monitoring system display has a rear view camera image that is continuously displayed together with the gauges and important vehicle information. This enables the operator to carry out work while checking the surrounding area.

Rear view camera



Rear view image on monitor



Low Vibration with Viscous Cab Mounts

The PC210LC-11 and PC210LCi-11 uses viscous mounts for the cab that incorporate a longer stroke and the addition of a spring. The cab damper mounting combined with a high rigidity deck reduces vibration at the operator's seat.

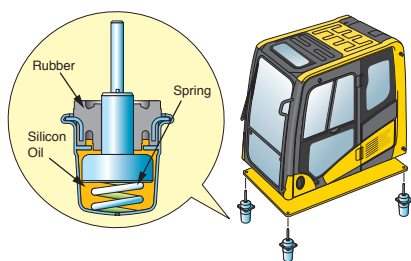

General Features

Secondary engine shut down switch at base of seat to shutdown the engine.



Lock lever

Seat belt retractable

Tempered & tinted glass

Large mirrors

Slip-resistant plates

Thermal and fan guards

Pump/engine room partition

Travel alarm

Large cab entrance step

Left and right side handrails



Seat belt caution indicator



KOMATSU PARTS & SERVICE SUPPORT



KOMATSU CARE

Program Includes:

*The PC210LC-11 and PC210LCi comes standard with complimentary factory scheduled maintenance for the first 3 Years or 2,000 Hours, whichever comes first.

Planned Maintenance Intervals at:

500/1000/1500/2000 hour intervals. (250 hr. initial interval for some products) Complimentary Maintenance Interval includes: Replacement of Oils & Fluid Filters with genuine Komatsu Parts, 50-Point inspection, Komatsu Oil & Wear Analysis Sampling (KOWA)/Travel & Mileage (distance set by distributor; additional charges may apply)

Benefits of Using Komatsu CARE

- Assurance of Proper Maintenance with OEM Parts & Service
- Increased Uptime & Efficiency
- Factory Certified Technicians Performing Work
- Cost of Ownership Savings
- Transferable Upon Resale

Complimentary DPF Exchange

The PC210LC-11 and PC210LCi comes standard with 2 Complimentary DPF Exchange units for the first 5 Years or 9000 hours whichever comes first. The suggested DPF Exchange unit service intervals are 4500 hours & 9000 hours. End user must have authorized Komatsu distributor perform the removal & installation of the DPF.

Complimentary SCR System Maintenance

The PC210LC-11 and PC210LCi also includes 2 factory recommended services of the Selective Catalytic Reduction (SCR) Diesel Exhaust Fluid (DEF) system during the first 5 Years or 9000 hours whichever comes first. The service includes factory recommended DEF tank flush & strainer cleaning at the suggested service intervals of 4500 hours & 9000 hours.

Komatsu CARE® – Extended Coverage

- Extended Coverage can provide peace of mind by protecting customers from unplanned expenses that effect cash flow
- Purchasing extended coverage locks-in the cost of covered parts and labor for the coverage period and helps turn these into fixed costs



Komatsu Parts Support

- 24/7/365 to fulfill your parts needs
- 9 parts Distribution Centers strategically located across the U.S. and Canada
- Distributor network of more than 300 locations across U.S. and Canada to serve you
- Online part ordering through Komatsu eParts
- Remanufactured components with same-as-new warranties at a significant cost reduction



Komatsu Oil and Wear Analysis (KOWA)

- KOWA detects fuel dilution, coolant leaks, and measures wear metals
- Proactively maintain your equipment
- Maximize availability and performance
- Can identify potential problems before they lead to major repairs
- Reduce life cycle cost by extending component life

Interval PM	500	1000	1500	2000
KOWA SAMPLING – (Engine, Hydraulics, Swing Circle, L & R Final Drives)	✓	✓	✓	✓
LUBRICATE MACHINE	✓	✓	✓	✓
LUBRICATE SWING CIRCLE	✓	✓	✓	✓
CHECK SWING PINION GREASE LEVEL AND ADD, WHEN NECESSARY	✓	✓	✓	✓
CHANGE ENGINE OIL	✓	✓	✓	✓
REPLACE ENGINE OIL FILTER	✓	✓	✓	✓
REPLACE FUEL PRE-FILTER	✓	✓	✓	✓
REPLACE AC FRESH & RECIRC AIR FILTERS	✓	✓	✓	✓
CLEAN AIR CLEANER ELEMENT	✓	✓	✓	✓
DRAIN SEDIMENT FROM FUEL TANK	✓	✓	✓	✓
COMPLETE 50 POINT INSPECTION FORM; LEAVE PINK COPY WITH CUSTOMER OR IN CAB	✓	✓	✓	✓
RESET MONITOR PANEL MAINTENANCE COUNTER FOR APPROPRIATE ITEMS	✓	✓	✓	✓
REPLACE HYDRAULIC TANK BREATHER ELEMENT		✓		✓
REPLACE DEF TANK BREATHER ELEMENT		✓		✓
REPLACE FUEL MAIN FILTER		✓		✓
REPLACE HYDRAULIC OIL FILTER ELEMENT		✓		✓
CHANGE SWING MACHINERY OIL		✓		✓
CHECK DAMPER CASE OIL LEVEL, ADD WHEN NECESSARY		✓		✓
CHANGE FINAL DRIVE OIL				✓
CLEAN HYDRAULIC TANK STRAINER				✓
REPLACE KCCV FILTER ELEMENT				✓
REPLACE DEF PUMP FILTER				✓
FACTORY TRAINED TECHNICIAN LABOR	✓	✓	✓	✓
2 DPF Exchanges at 4,500 Hrs and 9,000 Hrs.				
2 SCR System Maintenance Services at 4,500 Hrs. and 9000 Hrs.				

* Certain exclusions and limitations apply. Refer to the customer certificate for complete program details and eligibility. Komatsu® and Komatsu Care® are registered trademarks of Komatsu Ltd. Copyright 2021 Komatsu America Corp.

PC210LC-11 / PG210LC-11

KOMTRAX EQUIPMENT MONITORING



GET THE WHOLE STORY WITH
KOMTRAX®

✓ **WHAT**

- KOMTRAX is Komatsu's remote equipment monitoring and management system
- KOMTRAX **continuously monitors and records** machine health and operational data
- Information such as fuel consumption, utilization, and a detailed history **lowering owning and operating cost**

✓ **WHEN**

- Know when your machines are **running or idling** and make decisions that will improve your fleet utilization
- Detailed movement records ensure you know when and where your equipment is moved
- Up to date records allow you to **know when maintenance is due** and help you plan for future maintenance needs

✓ **WHERE**

- KOMTRAX data **can be accessed virtually anywhere** through your computer, the web or your smart phone
- Automatic alerts keep fleet managers up to date on the latest machine notifications

✓ **WHO**

- KOMTRAX is **standard** equipment on all Komatsu construction products



Photo may include optional equipment.

✓ **WHY**

- Knowledge is power - **make informed decisions** to manage your fleet better
- Knowing your idle time and fuel consumption will help maximize your machine efficiency
- **Take control of your equipment** - any time, anywhere



KOMTRAX®

For construction and compact equipment.

KOMTRAX Plus®

For production and mining class machines.

SPECIFICATIONS



ENGINE

Model..... Komatsu SAA6D107E-3*
 Type..... Water-cooled, 4-cycle, direct injection
 Aspiration..... Variable Geometry Turbocharged, aftercooled, cooled EGR
 Number of cylinders..... 6
 Bore..... 107 mm **4.21"**
 Stroke..... 124 mm **4.88"**
 Piston displacement..... 6.69 ltr **408 in³**
 Horsepower
 ISO 9249 / SAE J1349..... Net 122.8 kW **165 HP**
 Fan at maximum speed..... Net 118.6 kW **159 HP**
 Rated rpm..... 2000 rpm
 Fan drive method for cooling radiator..... Mechanical with viscous fan clutch
 Governor..... All-speed control, electronic
 *EPA Tier 4 Final emissions certified



HYDRAULICS

Type..... HydrauMind (Hydraulic Mechanical Intelligence New Design) system, closed-center system with load sensing valves and pressure compensated valves
 Number of selectable working modes..... 6
 Main pump:
 Type..... Variable displacement piston type
 Pumps for..... Boom, arm, bucket, swing, and travel circuits
 Maximum flow..... 475 ltr/min **125.5 gal/min**
 Supply for control circuit..... Self-reducing valve
 Hydraulic motors:
 Travel..... 2 x axial piston motors with parking brake
 Swing..... 1 x axial piston motor with swing holding brake
 Relief valve setting:
 Implement circuits..... 37.3 MPa 380 kg/cm² **5,400 psi**
 Travel circuit..... 37.3 MPa 380 kg/cm² **5,400 psi**
 Swing circuit..... 28.9 MPa 295 kg/cm² **4,190 psi**
 Pilot circuit..... 3.2 MPa 33 kg/cm² **470 psi**
 Hydraulic cylinders:
 (Number of cylinders – bore x stroke x rod diameter)
 Boom .. 2–130 mm x 1334 mm x 90 mm **5.1" x 52.5" x 3.5"**
 Arm 1–135 mm x 1490 mm x 95 mm **5.3" x 58.7" x 3.7"**
 Bucket.. 1–115 mm x 1105 mm x 80 mm **4.5" x 43.5" x 3.2"**



DRIVES AND BRAKES

Steering control..... Two levers with pedals
 Drive method..... Hydrostatic
 Maximum drawbar pull..... 202 kN 20570 kg **45,349 lb**
 Gradeability..... 70%, 35°
 Maximum travel speed: High..... 5.5 km/h **3.4 mph**
 (Auto-Shift) Mid..... 4.1 km/h **2.5 mph**
 (Auto-Shift) Low..... 3.0 km/h **1.9 mph**
 Service brake..... Hydraulic lock
 Parking brake..... Mechanical disc brake



SWING SYSTEM

Drive method..... Hydrostatic
 Swing reduction..... Planetary gear
 Swing circle lubrication..... Grease-bathed
 Service brake..... Hydraulic lock
 Holding brake/Swing lock..... Mechanical disc brake
 Swing speed..... 12.4 rpm
 Swing torque..... 6900 kg•m **49,907 ft lbs**



UNDERCARRIAGE

Center frame..... X-frame
 Track frame..... Box-section
 Seal of track..... Sealed track
 Track adjuster..... Hydraulic
 Number of shoes (each side)..... 49
 Number of carrier rollers (each side)..... 2
 Number of track rollers (each side)..... 9



COOLANT & LUBRICANT CAPACITY (REFILLING)

Fuel tank..... 400 ltr **105.7 U.S. gal**
 Coolant..... 30.7 ltr **8.1 U.S. gal**
 Engine..... 23.1 ltr **6.1 U.S. gal**
 Final drive, each side..... 5.0 ltr **1.3 U.S. gal**
 Swing drive..... 6.5 ltr **1.7 U.S. gal**
 Hydraulic tank..... 132 ltr **34.9 U.S. gal**
 Hydraulic system..... 234 ltr **61.8 U.S. gal**
 DEF tank..... 23.1 ltr **6.1 U.S. gal**



SOUND PERFORMANCE

Exterior – ISO 6395..... 100 dB(A)
 Interior – ISO 6396..... 66 dB(A)



OPERATING WEIGHT (APPROXIMATE)

Operating weight includes 5700 mm **18'8"** one-piece boom, 2925 mm **9'7"** arm, SAE heaped 1.19 m³ **1.57 yd³** bucket, rated capacity of lubricants, coolant, full fuel tank, operator, and standard equipment.

Triple-Grouser Shoes	Operating Weight	Ground Pressure (ISO 16754)
700 mm 28"	24160 kg 53,265 lb	0.47 kg/cm ² 6.7 psi
800 mm 31.5"	24440 kg 53,882 lb	0.42 kg/cm ² 5.9 psi

Component Weights

Arm including bucket cylinder and linkage
 2900 mm **9'7"** HD arm assembly..... 1136 kg **2,505 lb**
 2900 mm **9'7"** HD arm assembly w/piping..... 1200 kg **2,646 lb**
One piece boom including arm cylinder
 5700 mm **18'8"** boom assembly..... 1885 kg **4,156 lb**
 5700 mm **18'8"** HD boom assembly w/piping.. 1953 kg **4,306 lb**
 Boom cylinders x 2..... 205 kg **452 lb**
 Counterweight (standard)..... 4370 kg **9,634 lb**
 1.19 m³ **1.57 yd³** bucket - 48" width..... 949 kg **2,092 lb**



DIMENSIONS

Arm Length	2925 mm	9'7"
A Overall length	9705 mm	31'10"
B Length on ground (transport)	5000 mm	16'5"
C Overall height (to top of boom)*	2995 mm	9'10"
D Overall width	3080 mm	10'1"
E Overall height (to top of cab)*	3045 mm	10'0"
F Overall height (to top of handrail)*	3135 mm	10'3"
G Overall height (to top of GNSS antenna)*	3205 mm	10'6"
H Ground clearance, counterweight	1085 mm	3'7"
I Ground clearance, minimum	440 mm	1'5"
J Tail swing radius	3020 mm	9'11"
K Track length on ground	3655 mm	12'0"
L Track length	4450 mm	14'7"
M Track gauge	2380 mm	7'10"
N Width of crawler	3080 mm	10'1"
O Shoe width	700 mm	28"
P Grouser height	26 mm	1"
Q Machine height to top of counterweight	2250 mm	7'5"
R Machine height to top of engine cover	2765 mm	9'1"
S Machine upper width	2705 mm	8'10"
T Distance, swing center to rear end	2990 mm	9'10"

* : Including grouser height

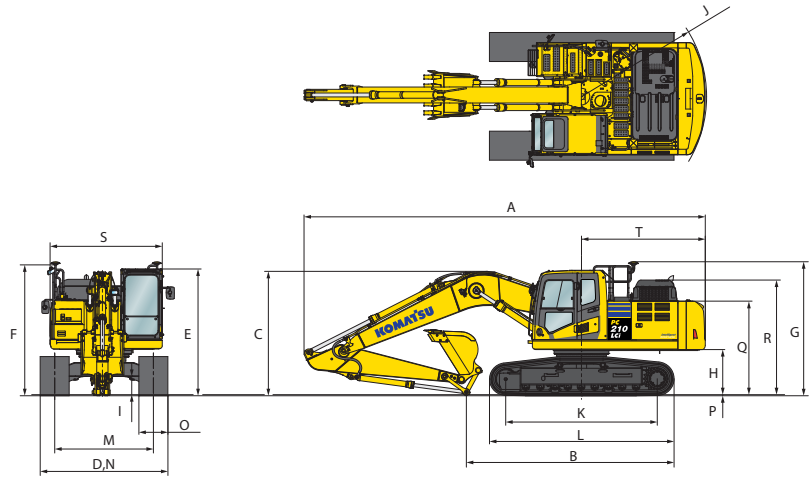

BACKHOE BUCKET, ARM AND BOOM COMBINATION

Bucket Type	Bucket			5.7 m (18'8") Boom	
	Capacity	Width	Weight	2.9 m (9'7")	
Komatsu TL	0.50 m ³	0.66 yd³	610 mm 24"	605 kg 1,334 lb	●
	0.67 m ³	0.88 yd³	762 mm 30"	689 kg 1,518 lb	●
	0.85 m ³	1.11 yd³	914 mm 36"	780 kg 1,719 lb	●
	1.02 m ³	1.34 yd³	1067 mm 42"	857 kg 1,890 lb	○
	1.20 m ³	1.57 yd³	1219 mm 48"	949 kg 2,092 lb	□
Komatsu HP	0.50 m ³	0.66 yd³	610 mm 24"	652 kg 1,437 lb	●
	0.67 m ³	0.88 yd³	762 mm 30"	763 kg 1,681 lb	●
	0.85 m ³	1.11 yd³	914 mm 36"	868 kg 1,913 lb	●
	1.02 m ³	1.34 yd³	1067 mm 42"	950 kg 2,095 lb	○
	1.20 m ³	1.57 yd³	1219 mm 48"	1066 kg 2,349 lb	⊙
Komatsu HPS	0.50 m ³	0.66 yd³	610 mm 24"	724 kg 1,597 lb	●
	0.67 m ³	0.88 yd³	762 mm 30"	840 kg 1,851 lb	●
	0.85 m ³	1.11 yd³	914 mm 36"	962 kg 2,120 lb	●
	1.02 m ³	1.34 yd³	1067 mm 42"	1061 kg 2,339 lb	□
	1.20 m ³	1.57 yd³	1219 mm 48"	1193 kg 2,630 lb	⊙
Komatsu HPX	0.50 m ³	0.66 yd³	610 mm 24"	824 kg 1,817 lb	●
	0.67 m ³	0.88 yd³	762 mm 30"	939 kg 2,071 lb	●
	0.85 m ³	1.11 yd³	914 mm 36"	1061 kg 2,340 lb	○
	1.02 m ³	1.34 yd³	1067 mm 42"	1161 kg 2,559 lb	□
	1.20 m ³	1.57 yd³	1219 mm 48"	1293 kg 2,850 lb	⊙

For best PC210LCi-11 semi-automatic machine control performance, observe maximum attachment weight:

- 1600 kg **3,528 lb** maximum for 2925 mm **9'7"** standard arm assembly

Exceeding recommended attachment weights may negatively impact performance and accuracy of semi-automatic function.

- - Used with material weights up to 3,500 lb/yd³ - Quarry/rock/high abrasion applications
- - Used with material weights up to 2,500 lb/yd³ - General construction

- - Used with material weights up to 3,000 lb/yd³ - Tough digging applications
- ⊙ - Used with material weights up to 2,000 lb/yd³ - Light materials applications
- X - Not useable

SPECIFICATIONS



WORKING RANGE

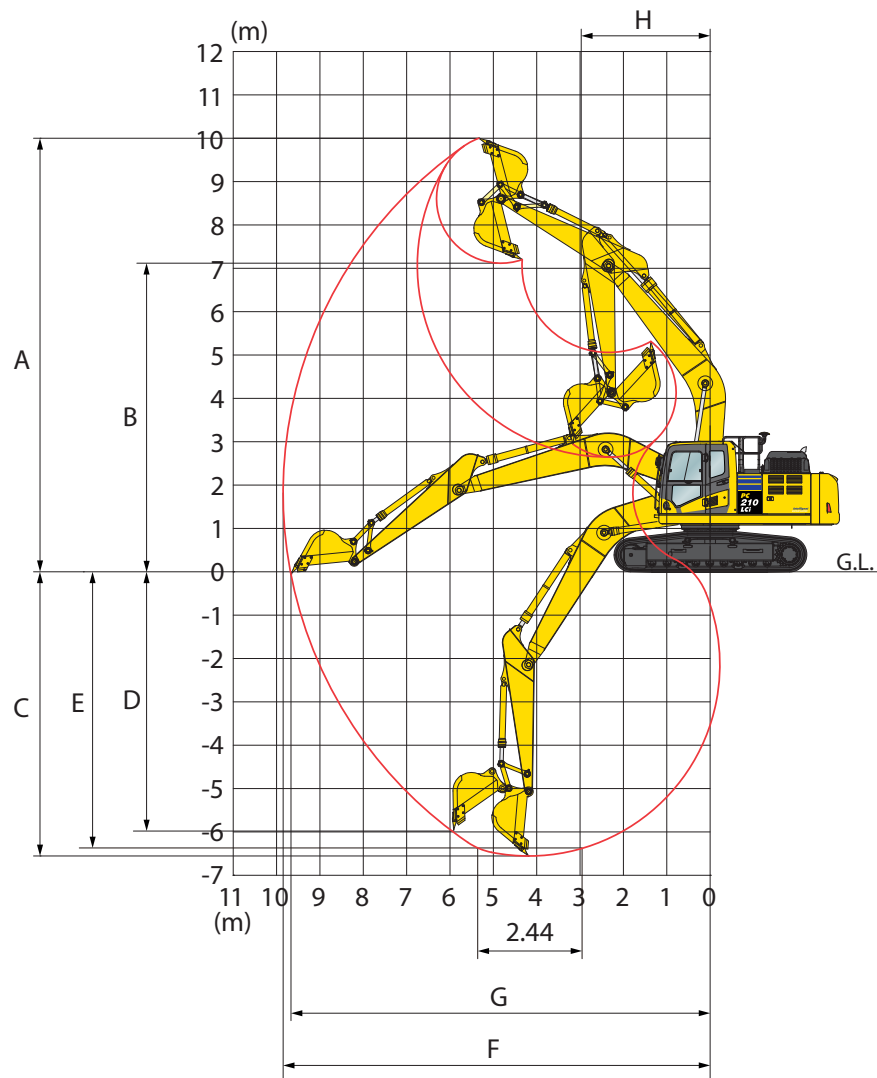

	Arm Length	2925 mm	9'7"
A	Max. digging height	9970 mm	32'9"
B	Max. dumping height	7110 mm	23'4"
C	Max. digging depth	6620 mm	21'9"
D	Max. vertical wall digging depth	5980 mm	19'7"
E	Max. digging depth for 8' level bottom	6370 mm	20'11"
F	Max. digging reach	9875 mm	32'5"
G	Max. digging reach at ground level	9700 mm	31'10"
H	Min. swing radius	3040 mm	10' 0"
SAE rating	Bucket digging force at power max.	132 kN 13500 kg / 29,762 lb	
	Arm crowd force at power max.	103 kN 10500 kg / 23,149 lb	
ISO rating	Bucket digging force at power max.	149 kN 15200 kg / 33,510 lb	
	Arm crowd force at power max.	108 kN 11000 kg / 24,251 lb	

PG210LG-11 / PG210LGH-11



LIFT CAPACITIES



LIFTING CAPACITY WITH LIFTING MODE

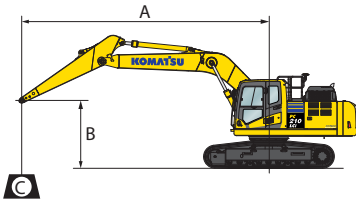

- A: Reach from swing center
- B: Bucket hook height
- C: Lifting capacity
- Cf: Rating over front
- Cs: Rating over side
- ⊗: Rating at maximum reach

- Conditions:
- 5700 mm 18' 8" one-piece boom
 - Counterweight: 4370 kg 9,634 lb
 - Bucket: None
 - Lifting mode: On

Arm: 2900 mm 9'7" HD		Bucket: None				Shoes: 700 mm 28"				Unit: kg lb			
B	A	1.5 m 5'		3.0 m 10'		4.6 m 15'		6.1 m 20'		7.6 m 25'		⊗ MAX	
	MAX	Cf	Cs	Cf	Cs	Cf	Cs	Cf	Cs	Cf	Cs	Cf	Cs
7.6 m 25'	6.0 m 20'											* 4100	* 4100
												* 9100	* 9100
6.1 m 20'	7.2 m 24'							* 6550	6100			* 3850	* 3850
								* 14400	13500			* 8500	* 8500
4.6 m 15'	7.9 m 26'							* 7200	5950	* 5250	4300	* 3800	* 3800
								* 15850	13200	* 11600	9500	* 8450	* 8450
3.0 m 10'	8.3 m 27'			* 12850	* 12850	* 10350	8650	* 8250	5750	6200	4200	* 3950	3700
				* 28300	* 28300	* 22850	19100	* 18200	12700	13650	9300	* 8700	8250
1.5 m 5'	8.4 m 27'					* 12550	8150	8400	5550	6050	4100	* 4200	3600
						* 27700	18050	18500	12200	13400	9050	* 9350	8000
0 m 0'	8.1 m 27'			* 7450	* 7450	12850	7900	8200	5350	6000	4000	* 4750	3700
				* 16500	* 16500	28300	17450	18100	11850	13200	8900	* 10500	8150
-1.5 m -5'	7.6 m 25'			* 12000	* 12000	12750	7800	8150	5300	* 5850	4000	* 5650	4000
				* 26500	* 26500	28100	17300	17950	11700	* 12950	8850	* 12550	8800
-3.0 m -10'	6.7 m 22'			* 18500	14950	12800	7900	8150	5350			7100	4700
				* 40850	33000	28250	17400	18050	11800			15650	10400
-4.6 m -15'	5.3 m 17'			* 14950	* 14950	* 10650	8100					* 8900	6650
				* 32950	* 32950	* 23500	17850					* 19700	14700

*Asterisk indicates load is limited by hydraulic capacity rather than tipping. Ratings are based on ISO standard No. 10567. Rated load capacity does not exceed 87% of hydraulic lift capacity or 75% of tipping load. Total weight of bucket and/or installed attachments must be deducted from the capacities shown above. Lift capacity chart is based on machine located on a solid, level and uniform surface. Load ratings are at the arm bucket pin location, use of any attachment point in a different location to handle objects could affect excavator lift performance.



LIFTING CAPACITY WITH LIFTING MODE

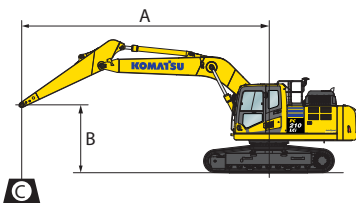

- A: Reach from swing center
- B: Bucket hook height
- C: Lifting capacity
- Cf: Rating over front
- Cs: Rating over side
- ⊗: Rating at maximum reach

- Conditions:
- 5700 mm 18' 8" one-piece boom
 - Counterweight: 4370 kg 9,634 lb
 - Bucket: None
 - Lifting mode: On

Arm: 2900 mm 9'7" HD		Bucket: None				Shoes: 800 mm 31.5"				Unit: kg lb			
B	A	1.5 m 5'		3.0 m 10'		4.6 m 15'		6.1 m 20'		7.6 m 25'		⊗ MAX	
	MAX	Cf	Cs	Cf	Cs	Cf	Cs	Cf	Cs	Cf	Cs	Cf	Cs
7.6 m 25'	6.0 m 20'											* 4100	* 4100
												* 9100	* 9100
6.1 m 20'	7.2 m 24'							* 6550	6150			* 3850	* 3850
								* 14400	13650			* 8500	* 8500
4.6 m 15'	7.9 m 26'							* 7200	6050	* 5250	4350	* 3800	* 3800
								* 15850	13300	* 11600	9600	* 8450	* 8450
3.0 m 10'	8.3 m 27'			* 12850	* 12850	* 10350	8750	* 8250	5800	6250	4250	* 3950	3750
				* 28300	* 28300	* 22850	19250	* 18200	12850	13800	9400	* 8700	8300
1.5 m 5'	8.4 m 27'					* 12550	8250	8500	5600	6150	4160	* 4200	3650
						* 27700	18250	18700	12350	13550	9150	* 9350	8050
0 m 0'	8.1 m 27'			* 7450	* 7450	12950	8000	8300	5450	6050	4050	* 4750	3700
				* 16500	* 16500	28600	17650	18300	12000	13350	9000	* 10500	8250
-1.5 m -5'	7.6 m 25'			* 12000	* 12000	12850	7900	8200	5350	* 5850	4050	* 5650	4050
				* 26500	* 26500	28400	17450	18150	11850	* 12950	8950	* 12550	8900
-3.0 m -10'	6.7 m 22'			* 18500	15100	12950	7950	8250	5400			7150	4750
				* 40850	33350	28550	17600	18250	11900			15850	10500
-4.6 m -15'	5.3 m 17'			* 14950	* 14950	* 10650	8150					* 8900	6700
				* 32950	* 32950	* 23500	18050					* 19700	14850

*Asterisk indicates load is limited by hydraulic capacity rather than tipping. Ratings are based on ISO standard No. 10567. Rated load capacity does not exceed 87% of hydraulic lift capacity or 75% of tipping load. Total weight of bucket and/or installed attachments must be deducted from the capacities shown above. Lift capacity chart is based on machine located on a solid, level and uniform surface. Load ratings are at the arm bucket pin location, use of any attachment point in a different location to handle objects could affect excavator lift performance.



STANDARD EQUIPMENT

- 3 Speed travel with Auto shift
- Alternator, 90 Ampere, 24V
- AM/FM radio
- Automatic engine warm-up system
- Automatic air conditioner/heater
- Auto idle
- Auto Idle Shutdown (programmable)
- Lever lock Auto-lock
- Auxiliary input (3.5 mm jack)
- Batteries, large capacity
- Battery disconnect switch
- Boom and arm holding valves
- Carrier rollers (2 each side)
- Converter, (2) x 12V
- Counterweight, 4370 kg **9,634 lb**
- Dry type air cleaner, double element
- Electric horn
- EMMS monitoring system
- Engine, Komatsu SAA6D107E-3
- Extended work equipment grease interval
- Fan guard structure
- Fuel system pre-cleaner 10 micron
- High back air suspension seat, with heat
- Hydraulic track adjusters
- KOMTRAX® Level 5.0
- Large LCD color monitor, high resolution
- Lock lever
- Mirrors, (LH and RH)
- Operator Protective Top Guard (OPG), Level 1
- Operator Identification System
- Pattern change valve (ISO to BH control)
- Power maximizing system
- PPC hydraulic control system
- Pump/engine room partition cover
- Radiator and oil cooler dustproof net
- Rear reflectors
- Rearview monitoring system (1 camera)
- Revolving frame deck guard
- Revolving frame undercovers
- ROPS cab
- Seat belt, retractable, 76 mm **3"**
- Seat belt indicator
- Secondary engine shutoff switch
- Service valve
- Shoes, triple grouser, 800 mm **31.5"**
- Skylight
- Slip resistant foot plates
- Starter motor, 5.5kW/24V x 1
- Suction fan
- Thermal and fan guards
- Track frame undercover
- Track frame swivel guard
- Travel alarm
- Working lights, 2 (boom and RH front)
- Working mode selection system



OPTIONAL EQUIPMENT

- Additional front working lights, 2 cab roof lights
- Arm
 - 2925 mm **9'7"** HD arm assembly
 - 2925 mm **9'7"** HD arm assembly with piping
- Boom
 - 5700 mm **18'8"** HD boom assembly
 - 5700 mm **18'8"** HD boom assembly with piping
- Cab guards
 - Full front guard, OPG Level 1
 - Full front guard, OPG Level 2
 - Bolt-on top guard, OPG Level 2
- High pressure in-line hydraulic filters
- Hydraulic control unit, 1 actuator
- Komvision
- Rain visor
- Revolving frame undercovers, heavy duty
- Shoes, triple grouser, 700 mm **28"**
- Straight travel pedal
- Sun visor
- Track roller guards, full length



ATTACHMENT OPTIONS

- ATB IMU, field install kit
- Cab air pre-cleaner
- Hydraulic couplers
- Hydraulic kits, field installed
- Komvision, field install kit
- Super long fronts
- PSM thumbs
- Rockland thumbs
- Vandalism protection guards with storage box

For a complete list of available attachments, please contact your local Komatsu distributor.

KOMATSU®

Note: All comparisons and claims of improved performance made herein are made with respect to the prior Komatsu model unless otherwise specifically stated.